



*Rely on it.*

## INSTALLATION MANUAL

A magnifying glass with a long, thin handle and a large, clear lens, positioned horizontally across the middle of the page. The lens is focused on the text in the bottom left corner.

**RENOLIT**  
**ALKORPLAN**  
roofing products





Rely on it.

## Introduction

This guide sets out recommendations and installation methods for **RENOLIT** ALKORPLAN PVC membranes, and is intended as a quick “on the roof” reference to the techniques used when installing **RENOLIT** ALKORPLAN membranes.

It is based on current knowledge at the time of issue and may be subject to change without notice.

It is not intended as a substitute for practical training provided by **RENOLIT**, required for accreditation as an approved installer.

The installation of **RENOLIT** ALKORPLAN membranes must be performed only by specialised contractors whose operatives have undergone sufficient **RENOLIT** ALKORPLAN training.

Nothing contained in this guide may induce the application of **RENOLIT** membranes without observing existing standards, legal regulations, national and local building requirements, technical approvals or specifications and the rules and practices of good workmanship for this profession.

Please contact **RENOLIT** Technical Department for guidance on any specific matters not dealt with in the present guide



Rely on it.

## The RENOLIT group

The **RENOLIT** Group is an international leader in the manufacture of high-quality plastic films and related products for technical applications.

This independent family-owned business, which has been setting benchmarks for quality and innovation for 70 years, now employs a workforce of approximately 4,500 employees at more than 30 production plants and sales and technical support facilities around the world.

The **RENOLIT** brand represents technical competence, sophisticated product design and application-oriented service partnership worldwide.

**RENOLIT** offers a wide range of plastic films and connected services for many different industries. Among them are the construction and automotive industries, graphics and label markets, medical technology and furniture industry.

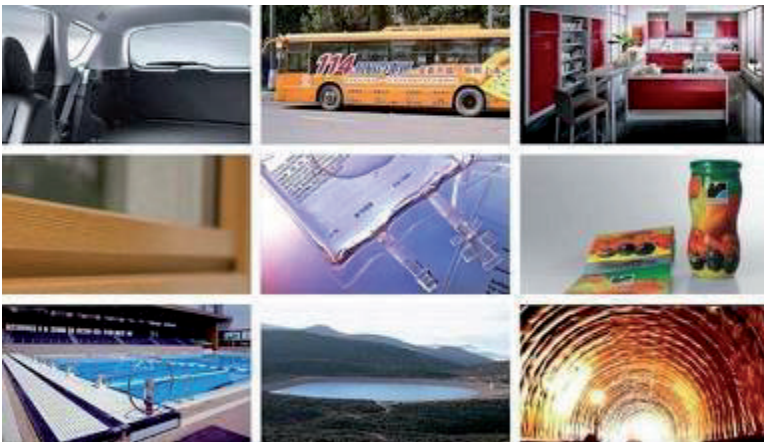

## RENOLIT ALKORPLAN roofing products

**RENOLIT** ALKORPLAN roofing products has been setting trends for synthetic roofing membranes in Europe for over 45 years. Our wide range of single ply roofing membranes and our innovative roof systems are used worldwide on new build and renovation projects.

Today **RENOLIT** is one of the leading synthetic roofing membrane manufacturers in Europe, and the **RENOLIT** ALKORPLAN brand has become globally renowned thanks to the high quality and longevity of our membranes.

**RENOLIT** roofing systems can be found on many well-known facilities including stadiums, schools, museums, hospitals, retail establishments, residential and commercial buildings.



**RENOLIT ALKORPLAN,**  
PVC-based roofing membrane



**RENOLIT ALKORTOP,**  
FPO-based roofing membrane

**RENOLIT ALKORPLAN** and **RENOLIT ALKORTOP** are not compatible and must not be installed in combination with one another.

**Please note:**

Contractors/installers will find general guidelines and installation principles in this manual specifically for use when installing **RENOLIT ALKORPLAN** roofing membranes.



*Rely on it.*

This information does not absolve users of their obligation to comply with existing regulations, statutory or local rules, technical approvals or the generally accepted rules of the trade.

Please contact **RENOLIT** for additional information about other products:

**RENOLIT UK**  
Station Road, Cramlington, Northumberland.  
NE23 8AQ

Tel : +44 (0) 1670 718283  
Fax: +44 (0) 1670 590096

[www.renolit.com/roofing](http://www.renolit.com/roofing)

## General information

### Storage

**RENOLIT ALKORPLAN** roofing membranes are supplied in rolls on pallets or in cases. **RENOLIT ALKORPLAN** membranes should be stored in a dry place or, if this is not possible, protected against dampness and exposure to rain, frost and snow.



When stored correctly, **RENOLIT** membranes can be welded without any additional cleaning.

### Labelling

**RENOLIT ALKORPLAN** rolls are individually labelled identifying the membrane batch, thickness, length and width.

All accessories used to install **RENOLIT ALKORPLAN** PVC systems have blue identification labels. A record should be kept of this label so that, in the event of a claim, it can be checked against laboratory test samples. Batch samples are kept of all material manufactured.

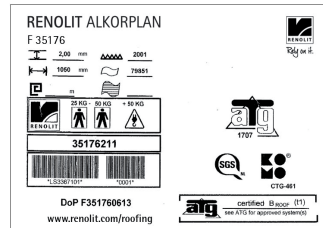

### RENOLIT ALKORPLAN

PVC EXTENSION ELEMENT FOR WATER OUTLET  
EXTENSION D'EVACUATION D'EAUX PLUVIALES EN PVC  
PVC - AUFSTOCKELEMENT FÜR GULLY

TYPE 81088-057

Colour - Couleur - Farbe: 71004

Diameter - Diamètre: 70-125 mm

Pieces - Pièces - Stücke: 1





## Cleaning

To be properly welded the overlaps and seam areas must be clean and dry.

Soiled **RENOLIT** ALKORPLAN should be cleaned prior to welding. Depending of the type of soiling, the material should be cleaned with water, detergent and water or **RENOLIT** ALKORPLUS<sub>81044</sub> PVC cleaner.



ALKORPLAN condition	Cleaning procedure (overlap area)
Soiled <b>RENOLIT</b> ALKORPLAN loose drilling dust, building site dirt)	<ul style="list-style-type: none"> <li>- Wipe off loose dirt</li> <li>- If necessary, wash down with water or detergent and water.</li> </ul>
Heavily soiled membrane (repair work, extensions to existing membrane, ...)	<ul style="list-style-type: none"> <li>- Wipe off loose dirt</li> <li>- Clean with water, using a brush or clean cloth, or detergent and water.</li> <li>- Remove heavily soiling with ALKORPLUS PVC cleaner, allow cleaner to evaporate completely</li> </ul>
Bitumen residue	Remove with ALKORPLUS PVC cleaner
Adhesive residue	Remove with ALKORPLUS PVC cleaner

### CAUTION!

ALL CONTACT BETWEEN **RENOLIT** ALKORPLUS<sub>81044</sub> PVC CLEANER AND EPS INSULATION PANELS SHOULD BE AVOIDED.

## ***Damage repair***

Should accidental damage occur after installation, repairs are simple to make.

NOTE. WHEN REPAIRING ANY REMAINING WATER IN THE LOCALITY MUST BE REMOVED SO AS LITTLE MOISTURE AS POSSIBLE IS ENTRAPPED. IN MOST CASES A SMALL AMOUNT OF RESIDUAL MOISTURE WILL BE ABLE TO EVAPORATE THROUGH THE **RENOLIT** ALKORPLAN PVC-P MEMBRANE.

Cut a patch of **RENOLIT** ALKORPLAN membrane that covers completely the damaged area and round the corners. The repair must overlap the edges of the damaged area by **at least 50 mm**.

Trace the circumference of the patch onto the surface and clean the area with a cloth and **RENOLIT** ALKORPLUS PVC-P cleaner.

Pre-weld and weld the patch by starting in the center.

### **NOTE.**

WHEN REPAIRING MEMBRANE NEW **RENOLIT** ALKORPLAN MEMBRANE MAY BE LAID UNDERNEATH THE EXISTING ROOFING AND THE UNDERSIDE OF THE LATTER WELDED ON TOP.

## Chemical compatibility

**RENOLIT** ALKORPLAN membranes are resistant to the environmental effects including an extensive range of materials and substrates.

FOR COMPATIBILITY OF SPECIFIC MATERIALS PLEASE CHECK WITH THE **RENOLIT** TECHNICAL DEPARTMENT.

**RENOLIT** ALKORPLAN roofing membranes cannot be laid directly to:

Substrate	Separation / protection layer
Extruded and expanded polystyrene insulation (EPS/XPS)	ALKORPLUS <sub>81001</sub> glass fleece, 120 g/m <sup>2</sup>
Unfaced polyurethane and polyisocyanurate insulation (PUR/PIR)	ALKORPLUS <sub>81001</sub> glass fleece, 120 g/m <sup>2</sup>
Bituminous substrates (incl. bitumen laminated insulation, old bituminous roofing membrane, etc.)	ALKORPLUS <sub>81005</sub> polyester fleece, 300 g/m <sup>2</sup>
Rough surfaces (e.g. concrete)	ALKORPLUS <sub>81005</sub> polyester fleece, 300 g/m <sup>2</sup>
Plywood, OSB and timber planking	ALKORPLUS <sub>81005</sub> polyester fleece, 180 g

Separation layers are loose laid and are to overlap one another by at least 50 mm.

**NOTE.** WITH LAMINATED INSULATION BOARD THE SEPARATION FUNCTION MUST BE GUARANTEED BY THE INSULATION BOARD MANUFACTURER.

**NOTE.** WITH FLEECE BACKED MEMBRANES THE FLEECE ACTS AS A SEPARATION LAYER.

As a general rule **RENOLIT** ALKORPLAN roofing membranes must not come into direct contact with bitumen (including bitumen laminated insulation, old bituminous roofing membrane, etc.).

A loose laid polyester separation layer of at least 300 g/m<sup>2</sup> is to be installed in order to prevent direct contact with bitumen. The rolls of polyester fleece are to overlap one another by at least 50 mm.

### **Plywood, OSB board and timber planking:**

Plain **RENOLIT** ALKORPLAN membranes must be separated away from timber substrate by loose laid **RENOLIT**<sub>81008</sub> 180 g/m<sup>2</sup> polyester separation layer.

### **WARNING!**

With fleece laminated membranes (**RENOLIT** ALKORPLAN A) the fleece acts as a separation layer, a separate polyester layer is thus not needed.

## Maintenance / Accessibility

### *Rules for the protection of roof membrane*

**RENOLIT** ALKORPLAN roofing membranes, provided they are installed in accordance with **RENOLIT guidelines** require little maintenance and need no additional protection against the elements.

**RENOLIT** ALKORPLAN roofing systems must not come into contact with bitumen, oils or tar.

**RENOLIT** roofing systems must be protected against mechanical damage. Sharp and rough materials, (metal swarf, screws, nails, etc.) can damage the roofing membrane and must be removed immediately or during annual roof inspections.

Should the use of ladders or other tools be required then they will need to be placed on a pressure distribution layer (timber boards without nails or sharp edges), in order to prevent damage to the membrane.

Roofs requiring routine access for maintenance and access to plant are to be provided with suitable dedicated walkways. Please refer to **RENOLIT WALKWAY** membranes.

New waterproofing installations, subsequent alterations or the installation of penetrations etc. are to be planned and carried out by an approved roofing contractor only.

When carrying out inspections and routine maintenance work, such as cleaning pipe outlets and gutters, all foreign material must be removed from the roof.

## ***Annual inspections***

Under BS6 229-1982, every roof must be maintained regularly at the owner's initiative. This maintenance is to include at least the following:

### ***After winter:***

- An overall inspection and repair to the waterproofing as necessary.
- A check on gutters, downpipes, outlets, etc.

### ***After autumn when the leaves have fallen:***

- An overall inspection and repair to the waterproofing as necessary.
- remove fallen leaves.
- remove moss, plant growth, extraneous objects, etc.

## Welding

When welding **RENOLIT** ALKORPLAN roofing membranes the area being welded must be clean and dry. Seams can only be welded successfully with clean and dry joints.

Minimum overlap requirements are:

- **50 mm for loose laid systems**
- **80 mm for bonded systems**
- **100 mm for mechanically fastened systems**

Welding work is to be suspended whenever the ambient temperature drops below 0 °C.

### *Manual welding*

#### Tools for manual welding

The following tools are required for welding **RENOLIT** ALKORPLAN roofing membranes manually:

1. Hot air welding gun (e.g. Leister Triac S or PID)
2. 20 mm wide nozzle for detailing.
3. 40 mm wide nozzle for seam welding.
4. 40 mm silicone roller for most welding.
5. 6 mm brass “penny” roller to weld awkward details.
6. Weld testing probe.



7. Tools for hot air gun maintenance brushes, screwdrivers, grips.
8. Small (2 inch) soft brush for welding gun filter maintenance.
9. Wire brush for nozzle cleaning.
10. Tools for measuring, marking and cutting.
11. Tape measure.
12. Scissors.
13. Retractable bladed craft knife.
14. Marker pen.
15. String line.
16. Tin snips for cutting **RENOLIT ALKORPLAN Metal.**





## General

Check before work commences that the welding gun nozzle is even and open across its entire width. Any PVC particles must be cleaned from the nozzle constantly.

The air supply filter must be clear and free from dust. Accumulated dust and dirt are to be removed using a brush or compressed air.

### Weld Testing

Make a sample weld on the material you will be using to test that the settings on your welding gun are correct. Check the weld sample with a destructive test. (See testing on page 16)



### Cables

To avoid a voltage drop, never use an excessively long extension cable or share a power cable with others. To prevent damage and fire, never use an extension cable that is still coiled on a roll.



Digital setting 460 - 480°C. Or dial setting 6 ½ - 8

## Manual welding procedure

Manual welding is performed in one or two stages:

### 1. Pre-weld

It may be advisable in special cases to use a pre-weld.

**Procedure:** Weld the overlap zone furthest back to leave a 40 mm opening.

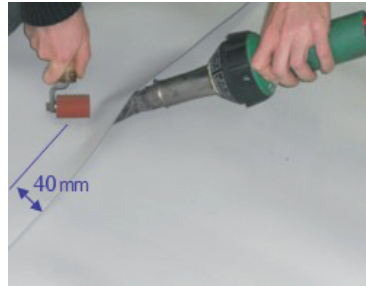

### 2. Final weld

**Procedure:** The welding nozzle is to be positioned at an angle of 45° to the joint overlap.

The outer edge of the welding nozzle should be approx. 2 mm outside the overlap.

The membrane is to be pressed down using the silicone roller.

Roll the weld with the silicone roller held about 10 mm from the nozzle of the gun, moving it back and forth,

parallel to the nozzle and angled toward the seam.

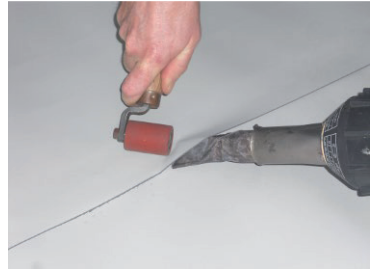

**Apart from initially maintaining material in position, Spot welds are unacceptable.**

The operator has 3 factors at his control:

- The heat of the welding gun
- The speed at which the welding gun is moved.
- The pressure of the roller on the overlap.

## T-weld

A T-weld is created when 3 layers meet.

The edge of the middle strip should be chamfered.

This can be done using the manual welding gun and a silicone roller.

After this the waterproofing membrane can be welded over the chamfered area.

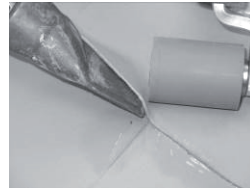

## End Lap

Transverse overlaps should be staggered in order to avoid cross seams.

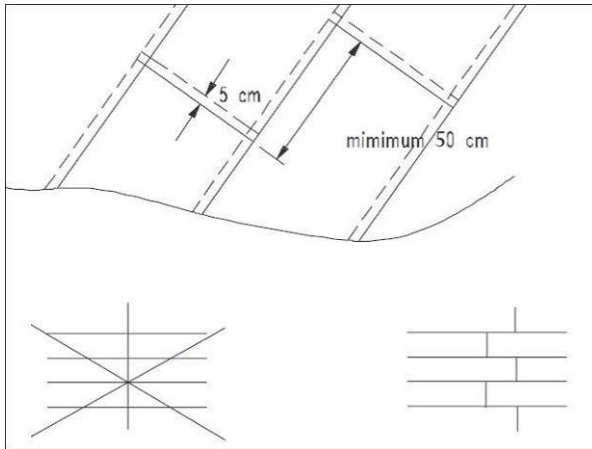

End laps from the end of the roll of **RENOLIT** ALKORPLAN roofing membrane must be cleaned to remove any tape or adhesive used in the rolling of the membrane and then must be overlapped by 50 mm and welded in the normal way. The end joints across the roof must be staggered to give a minimum of 500 mm between each joint.

## ***Automatic welding***

### **General**

Check before commencing that the welding unit nozzle is even and open across its entire width.

Any PVC particles must be cleaned from the nozzle constantly.

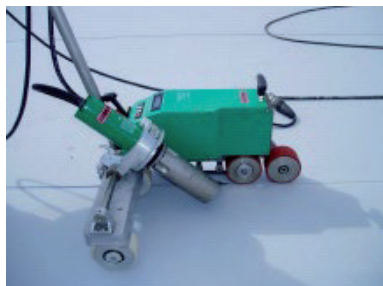

The air supply filter must be clear and free from dust. Accumulated dust and dirt are to be removed using a brush or compressed air.

The basic settings for the automatic welding machine must be checked by performing a test weld. The tool settings are to be adjusted if necessary.

**Carry out a test weld every time before commencing work or after a long interruption.**

Please contact **RENOLIT** for more information.

.....  
.....  
.....  
.....  
.....

.....  
.....  
.....  
.....  
.....

## ***Welding test***

Always carry out a test weld at the beginning of every working day and after every long interruption. Ensure the test weld seam has cooled down completely. A tensile force is to be applied to a 20 mm wide strip in order to test the weld. The joint must not come apart as a result of this. Any tears must be located outside the welded joint, or in the area of the reinforcement.

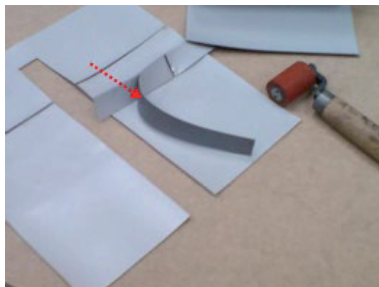

## ***Joint inspection***

### **Visual inspection**

The joint must be visually inspected in the course of welding. A continuous glossy strip along the weld seam will provide an early indication that the weld has been heated up sufficiently.

### **Mechanical joint inspection**

After welding, once the joint has cooled down, all seams should be confirmed as watertight.

To achieve this a weld test probe is passed along the seam.

The probe helps trace any overlap that has not been fully welded.

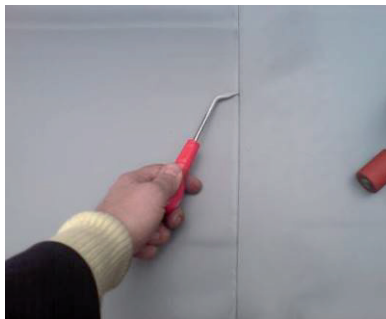

Any un-welded overlaps must be re-welded immediately with hot air.

## ***Seam sealer***

Once the membrane has been finally welded and weld quality checked, seam sealer may be applied.

The application of seam sealer is **mandatory** for standing water (e.g. gutter areas, rainwater drains, etc.), ballasted roofs and green roofs.



Ensure that the membrane is clean and dry before using seam sealer.

## ***Membrane Finish***

Exposed corners of **RENOLIT** ALKORPLAN roofing membrane must be rounded. Ensure that the diameter of this rounded effect on the corner is same over the whole roof. This will give the roof a neat appearance.



## Repairs

Before starting any repair, any remaining water in the locality must be removed so as little moisture as possible is entrapped. In most cases a small amount of residual moisture will be able to evaporate through the **RENOLIT** ALKORPLAN membrane.

The roof surface around the damaged area needs to be clean and dry over a sufficiently large surface. It should be cleaned using **RENOLIT** ALKORPLUS<sub>81044</sub> cleaning fluid.

For highly contaminated and older surfaces it may be decided to weld on the back of the existing membrane. It is less exposed to the elements and will weld better than the exposed face of the PVC membrane.

The same type of roofing membrane is to be used for the repair as was originally installed. The repair must overlap the edges of the damaged area by at least 50 mm. The joint with the existing roof covering is to be made in accordance with current **RENOLIT** ALKORPLAN guidelines

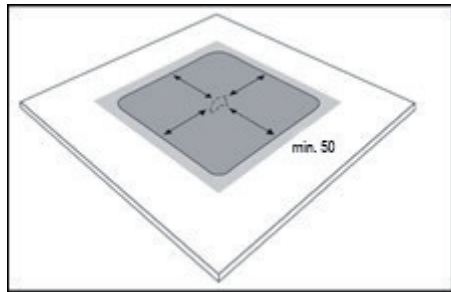



## ***Cleaning and Repairs***

It is good roofing practice to disguise patches. The customer does not want a new roof with patches in it. For patches in a new roof, cut the required length from a full width roll of **RENOLIT ALKORPLAN** roofing membrane and weld this piece into position as if it were a roll end. Round the corners in the normal way.



## RENOLIT ALKORPLAN F: Mechanically fastened system

**RENOLIT ALKORPLAN F** 35176/35276 roofing membranes are used for mechanically fastened systems. This roofing membrane features polyester reinforcement as standard.

**RENOLIT ALKORPLAN F** roofing membrane is mechanically fastened to the supporting structure using fasteners and washer tubes or plates.

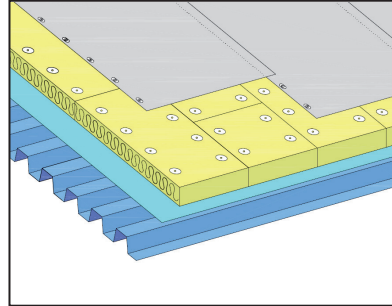

### *Vapour barrier*

A vapour barrier will be installed under the insulation, depending on the expected interior climate and the hygrothermal properties of the various materials used in the roof structure.

**RENOLIT ALKORPLUS<sub>81012</sub>** vapour barrier in low density polyethylene is loose laid with a minimum overlap of **100 mm**. The overlaps are to be vapour-proofed using a double-sided butyl adhesive tape, **RENOLIT ALKORPLUS<sub>81057</sub>**.

At terminations, the VCL is taken up and sealed to details and penetrations in accordance with Part L2 of the UK Building Regulations.

## ***Insulation***

Insulation is to be installed in accordance with the manufacturer's guidelines. Insulation boards are to be fastened independently from the **RENOLIT ALKORPLAN F** roofing membrane.

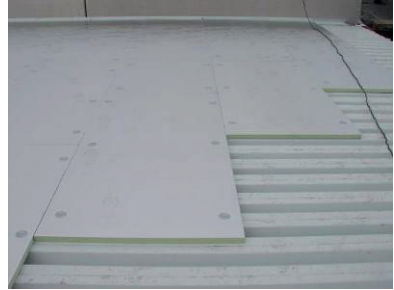

## ***Roof covering***

**RENOLIT ALKORPLAN F** roofing membranes must be installed perpendicular to the corrugated steel or aluminium deck.

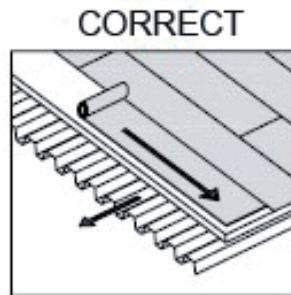

Screws and pressure plates are installed on the side lap. A marker line has been applied for this purpose.

The type and length of the fasteners will be determined by:

- the type of substrate
- the thickness of insulation

The number of fasteners and pressure plates per square meter must comply with the project specifications laid down in accordance with national guidelines (a wind calculation may be performed by **RENOLIT** upon request).

Regardless of the wind calculation **a minimum of 2 fasteners per square metre** must be respected at all times. The minimum spacing between fasteners is 150 mm. Only approved fasteners shall be used. If in doubt contact **RENOLIT** technical department. When installing the pressure plates ensure that they are not over tightened. These pressure plates work in a different way from those used to fix the insulation board. A fastener that is over tightened becomes ineffective and places greater strain on the adjacent fixings. Over tightened fasteners must be replaced.

Mechanically fixed membrane is installed with a minimum overlap of **100 mm** and a 40 mm weld. Overlaps should be hot-air welded.

There must always be a minimum of 10 mm between the edge of the pressure plate and the edge of the roofing membrane.

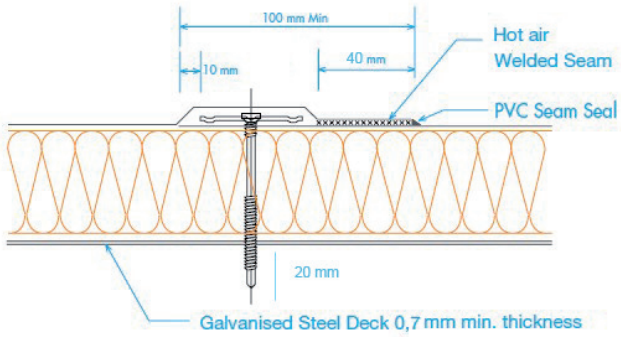

## **Perimeter Fixing, RENOLIT ALKORPLAN Metal**

At the perimeter of the roof, **RENOLIT** ALKORPLAN metal profiles are used to terminate the **RENOLIT** ALKORPLAN roofing membrane. They are prefabricated to the required profile for each job and are cut and bent to fit the edge detail of the roof.

Between sections **RENOLIT** ALKORPLAN metal profiles are fixed with a waterproof joint before the installation of the main **RENOLIT** ALKORPLAN field sheet. Unless otherwise advised, the metal profile is fixed through to the deck with self-drill/ tapping fasteners at 250 mm centres; with the first screw 50 mm from the end of the profile. The metal profiles are fixed leaving a minimum 5 mm gap between each section. The gap is covered with a 50 mm wide Aluband tape. This gives a 50 mm wide unwelded gap between sections which allows a sufficient area of membrane for expansion and contraction movement in the joint.

A 200 mm wide strap of **RENOLIT** ALKORPLAN is then welded over the joint to form a waterproof edge detail for the termination of the **RENOLIT** ALKORPLAN field sheet.

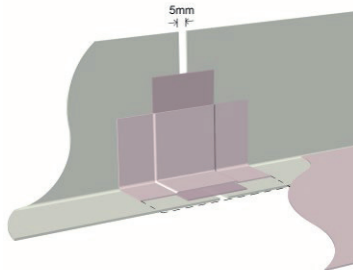

## ***Perimeter fixing, peel stop bar***

Alternatively **RENOLIT** ALKORPLAN<sup>35176/35276</sup> may be terminated in the perimeter corner with a peel stop bar **RENOLIT** ALKORPLUS<sup>81103</sup> and fixed at 250 mm centres.

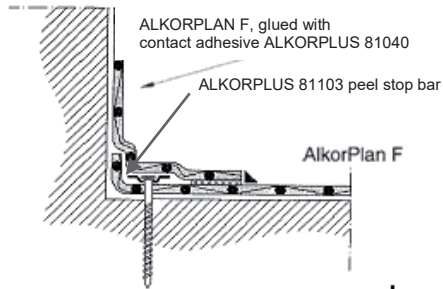

## ***Windproof roof edge and Upstand***

The roof edge and upstand must be finished in a wind-tight manner.

A windproof finish may be achieved by either bonding the **RENOLIT** ALKORPLAN F roofing membrane over the full surface using **RENOLIT** ALKORPLUS<sup>81040</sup> contact adhesive (adhesive consumption 2 x 150 g/m<sup>2</sup>) or through the use of expanding foam tape, **RENOLIT** ALKORPLUS<sup>81058</sup> on a mechanically fixed upstand and roof edge.

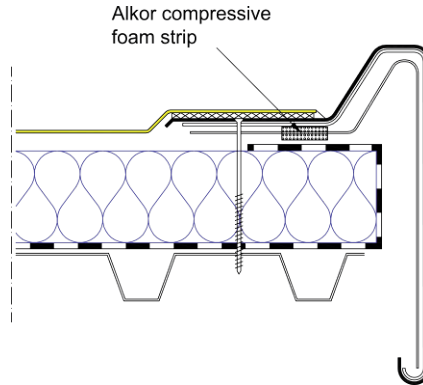

Please contact **RENOLIT** Technical for more information.

### ***Roof surface, changes in direction***

Where the roof shape changes from a horizontal plane to an angled or vertical plane, a section of **RENOLIT ALKORPLAN** metal profile must always be installed to facilitate this change of direction. The **RENOLIT ALKORPLAN F** roofing membrane is cut to fit the horizontal **RENOLIT ALKORPLAN** metalsheet plane and welded to it in the normal way. The **RENOLIT ALKORPLAN** metalsheet follows the change of direction and membrane is cut to fit the vertical leg of the **RENOLIT ALKORPLAN** metalsheet then welded to it.



## Fixing membrane to upstands

On upstands 500 mm and above in height, **RENOLIT ALKORPLAN F** may be either side lap fixed or welded to 50 mm deep **RENOLIT ALKORPLAN** Metal strips, screw fixed at 200 mm centres. Alternatively it may be adhered with contact adhesive.

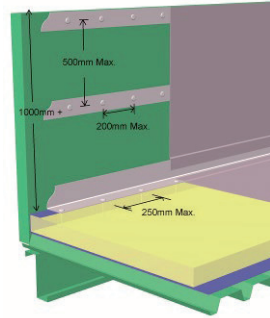

## Corners

Corners are formed by miter cutting and folding sections **RENOLIT ALKORPLAN** angle to the point of the corner and welding a prefabricated internal or external corner over the apex once the field sheet is in place. Care must be taken when installing corners to ensure that the membrane is welded into the point of the corner. Once the molded unit is spot welded into position the corner points are welded first, then the three curved sections.



Hot air weld with a 20 mm nozzle in combination with a penny roller.

## **RENOLIT ALKORPLAN A, Adhered system**

**RENOLIT ALKORPLAN A** roofing membrane is for fully bonded installations. It is a uniform roofing membrane with a 300 g/m<sup>2</sup> polyester fleece backing. This membrane is adhered to its substrate using **RENOLIT ALKORPLUS<sub>81068</sub>** polyurethane adhesive (PUR) or **RENOLIT ALKORPLUS<sub>81065</sub>** universal adhesive (**RENOLIT DUALFIX**).

**RENOLIT ALKORPLAN A** roofing membranes may be applied directly to old bituminous roofs for refurbishment.

### ***Substrate***

Before the roof deck is ready for applying bituminous primer, self-adhesive VCL, adhesive, insulation and membrane, it must be free from visible water, dust, loose elements, oil and grease.

Prior to installing the membrane, a test bond must be carried out to confirm adhesion strength and performance.

## **Bonding with RENOLIT ALKORPLUS<sub>81068</sub> PUR adhesive**

PUR adhesive may only be applied during dry weather and at a minimum outdoor and or deck temperature of 5 °C.

**RENOLIT ALKORPLAN** A roofing membrane is to be rolled out with an **50 mm overlap**.

The membrane is then rolled back up again halfway or folded back and the adhesive is applied either by hand or by using an applicator trolley.

The adhesive must be spread evenly with a plastic blade or 300 mm roller.

**Concentrations/pooling of adhesive must be avoided!**

**RENOLIT ALKORPLAN** A roofing membrane is rolled and pressed onto fresh adhesive once it has become tacky with the fleece backing on the underside.

Adhesive is applied for the other half of the roll in the same way.

**A 200 mm area free of glue** must be provided along end lap joints and at expansion or contraction gaps in the substrate.



The quantity of adhesive and its spread will be determined by the nature of the substrate

**RENOLIT ALKORPLAN A** is fully bonded.

Bond quality depends on even distribution of the adhesive across the surface of the insulation rather than on its thickness. Typical quantity 350g/m<sup>2</sup>.

## ***Bonding with RENOLIT ALKORPLUS<sub>81065</sub> Universal adhesive***

The **RENOLIT ALKORPLUS 81065** universal adhesive (DUALFIX) is a one component moisture curing polyurethane glue especially created for bonding fleece-backed synthetic roofing membranes to insulation or the roof surface. It can also be used for bonding insulation to either the roof surface or to insulation.



**For advice please contact RENOLIT Technical Dpt.**

**Bonding membrane:**

The surface should be clean of standing water, dust, grease and other contaminants. Rolls of roofing membrane may be laid out adjacent and rolled back in half or pulled back longitudinal, subsequent to positioning. The adhesive is atomized on the roof surface or insulation (consumption between 100 and 160 g/m<sup>2</sup>, depending on the surface) by means of a spray gun and compressor. Within 4 to 9 minutes when the adhesive is touch dry the fleece-backed

roofing membrane is rolled onto the adhesive. Any air trapped under the membrane may be removed by pressure of a broom. The roofing membrane should be pressed or rolled onto the adhesive until sufficient initial curing has taken place. Overall curing time for the adhesive is between 20 to 45 minutes depending on humidity.



#### Bonding insulation

The surface should be clean of standing water, dust, grease and other contaminants. The distance between beads should be 150 mm in the corners and perimeter and 300 mm in the centre depending on wind load (width of bead 20 to 25 mm). The adhesive is dispensed by means of a spray nozzle. The strands of adhesive are installed in a longitudinal fashion, the insulation boards are subsequently laid long dimension perpendicular to the strands. The insulation panels should be placed within 3 minutes of dispensing the adhesive, and should be pressed onto the adhesive until sufficient initial curing has taken place.

Curing time is between 20 to 45 minutes depending on humidity. Before commencement, a small bonding test should be carried out to verify if the adhesive is suitable for the application. A minimum bond of 1 N/mm is necessary.

## End lap joints

The end laps of **RENOLIT ALKORPLAN A** roofing membrane are butt jointed (**Figure A**). The joint should be covered with a 50 mm wide aluminium foil tape to maintain an un-welded area. A 200 mm wide cover strip of **RENOLIT ALKORPLAN D** or **RENOLIT ALKORPLAN F** is then welded across the joint. (**Figure B**).

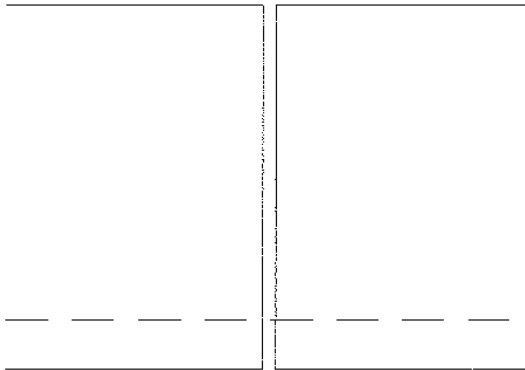

Figure A

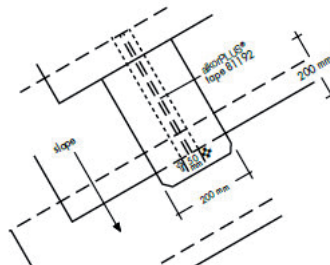

Figure B: Aluminium foil tape and non-glued area

## **Edge restraint**

Fixing **RENOLIT** ALKORPLAN A roofing membrane at its edge, for example, at the base of upstands and around protrusions is always required.

### **Mechanical edge restraint**

Linear fixing along ALKORMETAL fabricated metal sheet or spot fixing with fasteners and pressure plates, as per the **RENOLIT** ALKORPLAN F system. **RENOLIT** ALKORPLAN F membrane may then be mechanically fixed up and onto the upstand.

### **Bonded edge restraint**

Fully bonded **RENOLIT** ALKORPLAN A roofing membrane may be applied to both the field side and top of upstands. Alternatively **RENOLIT** ALKORPLAN A may be fully bonded on the field and **RENOLIT** ALKORPLAN F contact adhered to the wall (see Figure).

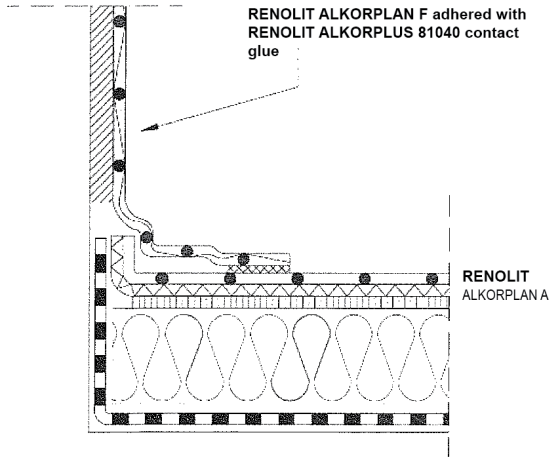

**Bonded edge detail and upstand**

### Wind-tight roof edge finish

Roof edges and all connections (rainwater outlets, etc.) are to be made wind-tight.

This can be achieved by full bonding of the roof edge using **RENOLIT ALKORPLUS<sub>81068</sub>** PUR adhesive or **RENOLIT ALKORPLUS<sub>81064</sub>** SBR adhesive for the **RENOLIT ALKORPLAN A** membrane, or using **RENOLIT ALKORPLUS<sub>81040</sub>** contact adhesive for **RENOLIT ALKORPLAN F** membrane.

Please contact **RENOLIT** for more information.

.....

.....

.....

.....

.....

.....



## RENOLIT ALKORPLAN L, Ballasted system

RENOLIT ALKORPLAN L roofing membrane is used for ballasted details. Its dedicated chemistry and manufacture allows **RENOLIT ALKORPLAN L** roofing membrane to be eminently suitable for loose laid ballasted systems.

This membrane must be rolled out flat, free from waves or creases and overlap the adjacent roll by **50 mm**.

ALL seams be must be finished with **seam sealer**.

### *Edge restraint*

RENOLIT ALKORPLAN L roofing membrane must be mechanically fixed at the edge, for example: at the base of upstands and around protrusions.

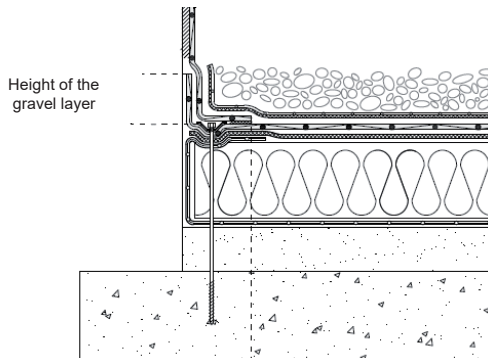

## ***Wind-proof roof edge finish***

- If the edge detail is to be covered (e.g. with a capping) **RENOLIT ALKORPLAN L** roofing membrane is to be used, adhered with **RENOLIT ALKORPLUS<sub>81040</sub>** contact adhesive over the full face. (Please note this membrane must not be installed in a position which leaves it exposed to direct sunlight).
- If the edge detail is not to be covered, **RENOLIT ALKORPLAN F** or **A** roofing membrane is to be used (Refer to **RENOLIT ALKORPLAN F** or **A** systems). In this situation, the **RENOLIT ALKORPLAN L** roofing membrane on the flat surface must be turned up by a minimum of 10 mm against the wall or to the height of the ballast layer.

## ***Protection layer***

A loose laid protective layer of **RENOLIT ALKORPLAN<sup>35121</sup>** must be installed on top of the waterproofing. This product is side lap welded. The thickness and type of the ballast layer is to be determined in accordance with current standards.



The ballast layer should be applied immediately after the **RENOLIT ALKORPLAN L** roofing membrane and its protection layer in order to offset wind forces.

## Green roofs

### RENOLIT ALKORPLAN LA Green



**RENOLIT ALKORPLAN LA** glass scrim reinforced and polyester fleece backed as waterproofing membrane within green roof systems.

Designing a green roof a fully bonded membrane is recommended.

The **RENOLIT ALKORPLAN LA** roofing membrane is installed as described for the **RENOLIT ALKORPLAN A** system.

Please refer to the **Adhered System** section for more information.

## RENOLIT ALKORPLAN Design Standing seam / Aesthetic profiles



The **RENOLIT** ALKORPLAN Design system combines the aesthetic appearance of a standing seam metal roof with all benefits of the **RENOLIT** ALKORPLAN roofing membranes.

The **RENOLIT** ALKORPLAN Design system consists of **RENOLIT** ALKORPLAN F or ALKORPLAN A roofing membrane and an extruded profile to achieve the standing seam appearance.

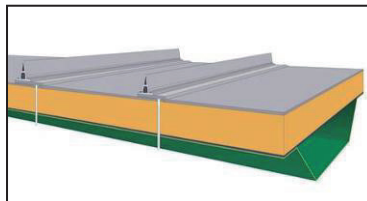

## **Installing RENOLIT ALKORPLAN Design profiles**

**RENOLIT ALKORPLAN** Design profiles are installed parallel with the roof slope and on top of the joint overlap. Additional intermediate rows of **RENOLIT ALKORPLAN** Design profiles may be installed between those on the overlaps. The correct position of intermediate rows of profile are marked with a chalk line.

The following can be used as a guide for intermediate **RENOLIT ALKORPLAN** Design placement to achieve the look of a metal roof.

### **Approx. on center distance for Design profiles**

475 mm	One between overlaps (ALKORPLAN F 1,05m)
500 m	Two between overlaps (ALKORPLAN F 1,60m)
673 mm	Two between overlaps (ALKORPLAN A 2,10m)

- Chalk a line to mark the correct placement of the ALKORPLAN Design profiles between the overlaps
- Tack the profile into position by spot welding every 5-10 cm. Grasp the profile with one hand and lift it off of the membrane enough to get the nozzle tip under it. Spot weld the profile in the middle of his section.
- Once the profiles have been positioned, both sides are hot air welded. Continue in a steady and consistent matter.  
The profiles are finished with seam sealer in the appropriate colour.

Rely on it.

There are two types of **RENOLIT ALKORPLAN** Design profiles available to imitate a standing seam: large profile and X-large profile.

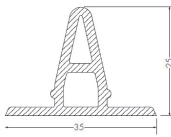

RENOLIT ALKORDESIGN profile Large

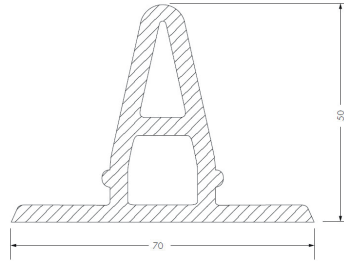

RENOLIT ALKORDESIGN profile X-Large

### Available colours



Lead Grey

73321



Charcoal

79851

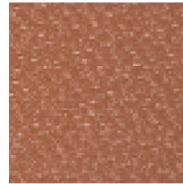

Copper

84040

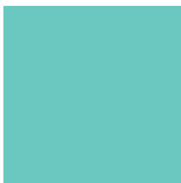

Copper green

60884



Terracotta

82119

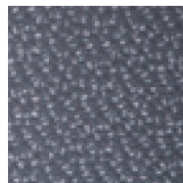

Silver

40100



## Detailing

### ***Fabricated RENOLIT ALKORPLAN metal sheet***

Fabricated lengths of **RENOLIT** ALKORPLAN Metal sheet are fixed mechanically, the selection of fastener type will depend on the roof build-up and substrate. Fasteners at the joint of the metal sheet should be positioned at around 50 mm in from the edge. The maximum spacing between fasteners fixed vertically is 250 mm. They are installed in a staggered pattern for optimum security.

A gap of 4mm must be left free between lengths of metal trim to allow for thermal expansion.

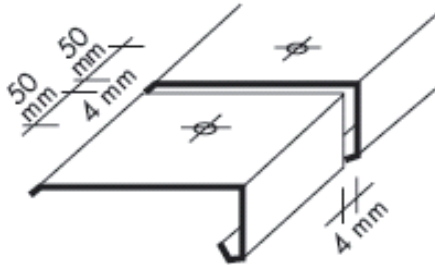

The joint is covered with:

- 50 mm wide aluminium foil tape **RENOLIT ALKORPLUS**<sub>81192</sub>.

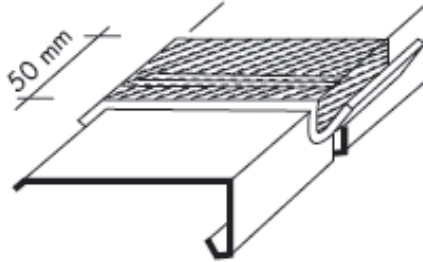

- Followed by a 200 mm wide junction strip of **RENOLIT ALKORPLAN D** (unreinforced) or **ALKORPLAN F** reinforced membrane welded to the metal strips with a 35 mm effective weld width.

Important: **an area approx. 100 mm over the joint remains un-welded.**

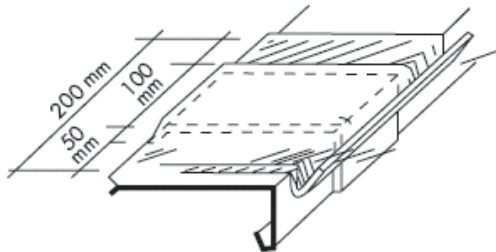



## ***Upstand - Internal corner 1***



Cut the ALKORMETAL drip section so it fits onto an external corner and fix it to the substrate.

When installing direct onto timber or masonry decks **RENOLIT** ALKORPLAN must have a lower protection layer.



Fix an external ALKORMETAL 50mm x 50mm (minimum) angle to the internal corner.

Fix an internal ALKORMETAL 100mm x 80mm (minimum) angle to the base.

Please note: the ALKORMETAL profile should always be taken as one piece around the corner.



Weld the field sheet to the base of the ALKORMETAL leaving a gap of 20mm between the edge of the membrane and the vertical face of the profile.

Weld **RENOLIT** ALKORPLAN membrane to the vertical faces of the ALKORMETAL angles.



Weld **RENOLIT** ALKORPLAN membrane to the horizontal faces of the ALKORMETAL drip and angle.



Position the **RENOLIT** ALKORPLUS prefabricated corner pieces in the corners.

Hand weld the corners using the 20 mm nozzle. Work from the inside outwards.

## ***Upstand - Internal corner 2***

Cut the ALKORMETAL drip section so it fits onto an external corner and fix it to the substrate.



A strip of **RENOLIT** ALKORPLAN D is to be welded over the cut edge.

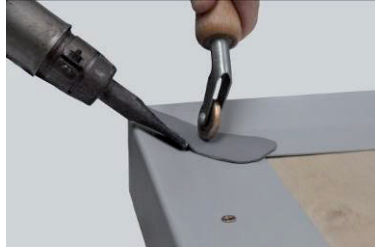

Turn the membranes in the roof deck up by 30 to 50 mm against the upstand and fix along the perimeter edge.



**Please note: As an alternative method of perimeter fixing a peel stop bar may be installed along the edge, RENOLIT ALKORPLUS<sub>81103</sub>.**



The fold in the corner should be welded using a manual hot air gun.



Cut an upstand strip of **RENOLIT ALKORPLAN** the same height as the upstand to be waterproofed + 100 mm for overlap with the field sheet.

Position/tack weld the upstand strip on the **RENOLIT** ALKORPLAN metal edge profile as illustrated so it can be folded into the corner.



Weld the upstand strip onto the field sheet, to form an upright fold in the corner.



Cut away a section of membrane from the upstand strip.

Break the tack weld and pull back the membrane strip. Apply **RENOLIT** ALKORPLUS<sup>81040</sup> contact adhesive to the entire face of the upstand and the **RENOLIT** ALKORPLAN upstand strip. Allow time for the adhesive to go tacky on both faces then smooth the membrane into place and weld the upstand strip fully and securely to the ALKOR metal edge profile.



Weld up the fold to form a waterproof pocket. Work from the inside outwards.



Follow the same procedure for the adjacent upstand. Cut the sheet into the corner as shown.



Position the **RENOLIT** ALKORPLUS prefabricated corner pieces in the corners.

Hand weld the prefabricated corners using the 20 mm nozzle. Work from the inside outwards.

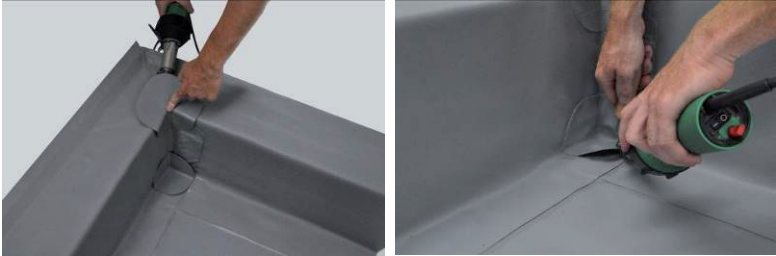

Apply seam sealer along the welded seams.



## ***Uprstand - External corner 3***

Cut the metal sheet strip so it fits onto an internal corner and fix it to the substrate.



Cover the exposed part of the corner by welding a patch of **RENOLIT ALKORPLAN D** on top.





Turn the membranes in the roof deck up by 30 to 50 mm against the upstand and install an edge restraint.

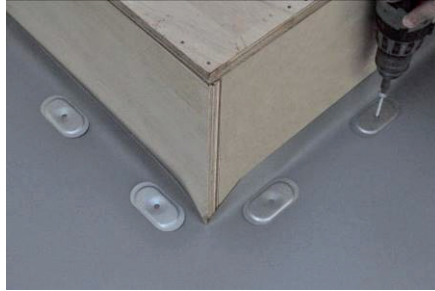

Weld a patch of **RENOLIT ALKORPLAN D** to the apex of the corner.



Cut an upstand strip of **RENOLIT ALKORPLAN** of the same height as the upstand to be waterproofed + 100 mm for the overlap with the field sheet.

Position the upstand strip on the **RENOLIT ALKORPLAN** metal sheet profile by tack welding and weld the overlap fully and securely to the field sheet.

Cut the overlap on the field sheet in a straight line from the corner of the membrane to the internal corner.



Detach the locating welds on the **RENOLIT** ALKORPLAN metal sheet profile and apply contact adhesive to the entire face of both the upstand and upstand strip. Free any creases around the corner. Allow time for the adhesive to go tacky on both faces then smooth the membrane into place and weld the upstand strip fully and securely to the metal edge profile.

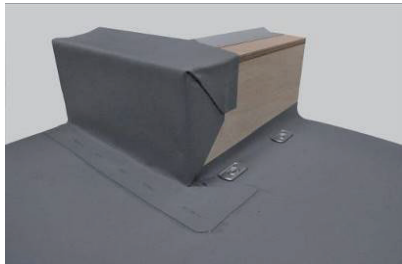

Weld the down the mitre fold to form a pocket. Weld inside the pocket working from the inside outwards

Cut a second upstand strip to size, apply adhesive to the entire face of the upstand strip fix in place and weld the overlaps.

Leave a 20 mm 'half round' over to weld the corner and make it waterproof.

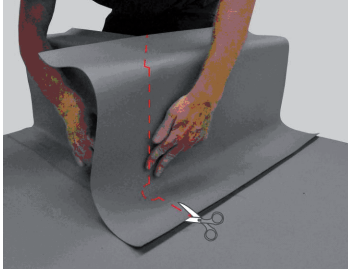

Position the **RENOLIT** ALKORPLUS prefabricated corner pieces in the corners.

Hand weld the prefabricated corners using the 20 mm nozzle. Always work from the inside outwards.

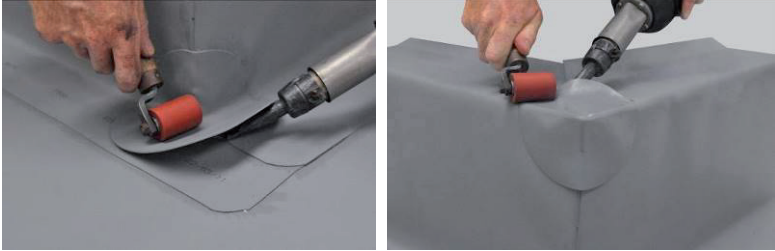

Apply seam sealer along the welded seams.

## ***Dome Rooflight***

Install a mechanical edge restraint around the dome aperture.

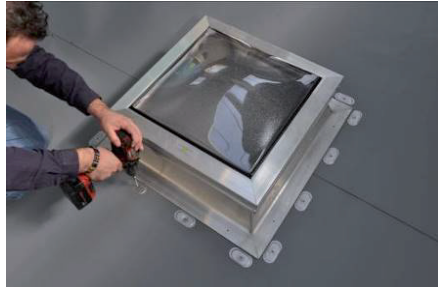

Cut four (identical) upstand strips of **RENOLIT ALKORPLAN** in order to waterproof the dome upstands.  
Allow 100 mm for the joint with the field sheet.

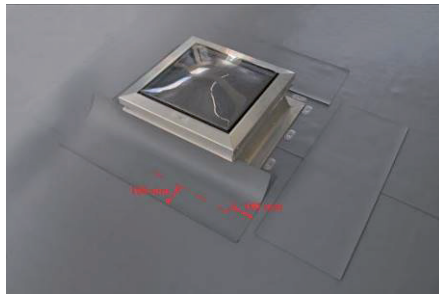

Apply **RENOLIT ALKORPLUS<sub>81040</sub>** contact adhesive to two opposing sides of the skylight dome and to two cover strips.

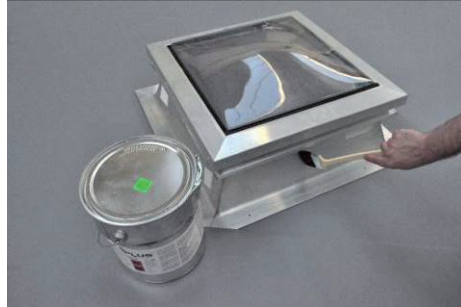

Bond them to the opposing sides of the skylight dome and cut the corners as illustrated.



**Ensure the job is free from trapped air.**

Fold the upstand strip around the edges of the skylight dome and bond them securely.



Cut the two remaining upstand strips along the line, as illustrated. Leave a 20 mm 'half round' over to weld the corner and make it waterproof.

**Ensure the weld areas are kept free from adhesive!**

Mark the adhesive areas on the cover strips.

Stick the two remaining cover strips down securely without creasing.

Weld the seam joints by hand and apply seam sealer along the weld edge.

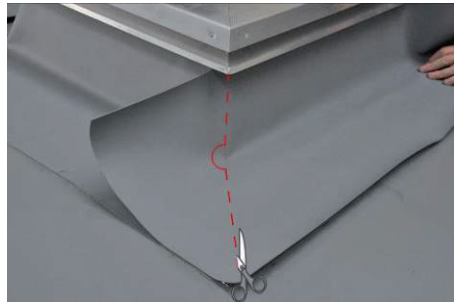

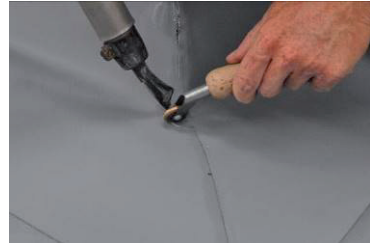
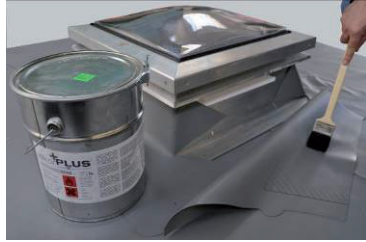



## Rainwater drainage

### Flexible rainwater outlets

Use only **RENOLIT** ALKORPLUS prefabricated outlets.

These outlets are used for vertical rainwater drainage only.

After the membrane has been installed, cut a hole around the outlet that is approximately 20 mm larger than the diameter of the prefabricated outlet.

The field sheet needs to be mechanically fastened or adhered with PU adhesive around the opening.

Weld the prefabricated outlet to the field sheet using the 20 mm wide nozzle.

The welded edge must be finished with seam sealer.

### Stainless steel outlets with PVC flange

After the field sheet has been installed, an adequate opening is cut out of the membrane.

The outlet is fitted and the metal flashing plate is fastened mechanically to the deck.

The PVC flange is hot air welded to the field sheet.



Welded seams must be finished with seam sealer.



## ***Rainwater Outlet (horizontal & vertical)***

Use only **RENOLIT ALKORPLUS** plates in PVC-u.

### **General**

Bond a PVC outlet of the same diameter in advance into the flashing plate (using PVC-u adhesive).

Cut a flange in **RENOLIT ALKORPLAN** membrane, as illustrated. The membrane piece must be at least 50 mm larger on all sides than the rigid PVC plate. Cut a hole in the middle of the flange approximately 20 mm larger than the diameter of the plate.

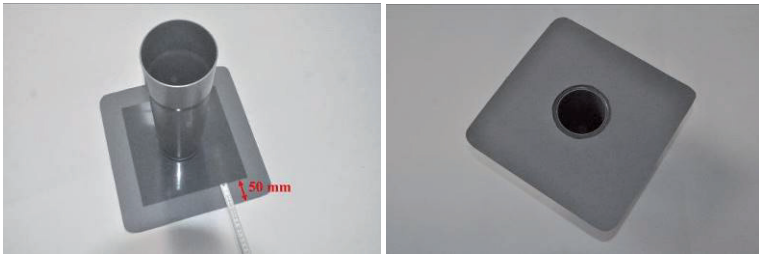

Weld the flange by hand to the prefabricated outlet by means of hot air (20 mm wide nozzle) or solvent weld. Keep a weld-free area in the four corners for mechanically fixing the rigid plate to the upstand or deck.



## At the upstand edge

In order to provide drainage at roof deck level, the plate must be folded after heating (see photos below).



Fasten the prepared outlet (mechanically) to the upstand and weld the flange securely to the field sheet.

All welded seams must be finished with seam sealer.



### ***Sealing the base of a circular protrusion***

Install a mechanical edge restraint to the **RENOLIT** ALKORPLAN around the base of the protrusion.

Cut a rectangle of **RENOLIT** ALKORPLAN membrane: width = size of the circumference + 50 mm. Minimum height, 150 mm or equal to the height of the pipe.

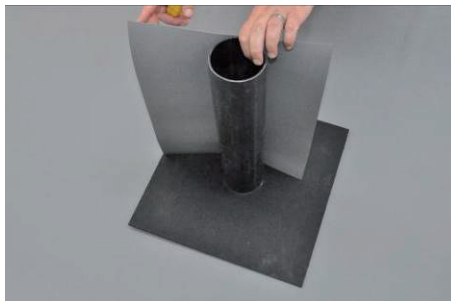

This strip is glued around the pipe using **RENOLIT ALKORPLUS 81040** contact adhesive. The overlap is hot-air welded on the vertical lap.



Cut a base flange in **RENOLIT ALKORPLAN D** (unreinforced membrane). The flange must be at least 150 mm larger on all sides of the circumference. Cut a hole in the middle of the flange approximately half the diameter of the pipe.

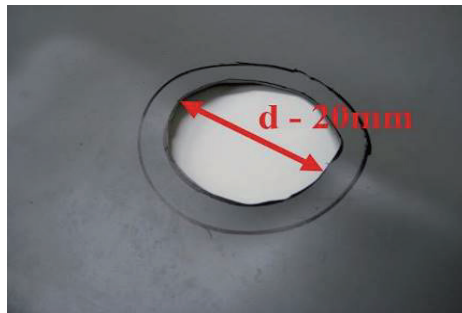

Heat the membrane all around the flange opening and then slide the flange over the pipe flashing to create a lip. Press the flange membrane firmly against the field sheet.

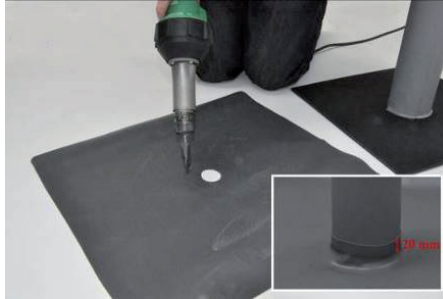

Weld the 20 mm lip using **RENOLIT ALKORPLUS<sub>81025</sub>** solvent and finish the seam with seam sealer.



Weld the **RENOLIT** ALKORPLAN D flange to the field sheet with a minimum width of 40 mm around the perimeter.



Finish the pipe flashing with a clamping ring + mastic or a storm collar.

If the pipe flashing is made of PVC-u, the **RENOLIT** ALKORPLAN D flange can be welded directly to the pipe flashing.

## Summary

### Longitudinal overlaps

<b>RENOLIT ALKORPLAN F</b>	100 mm
<b>RENOLIT ALKORPLAN A</b>	80 mm
<b>RENOLIT ALKORPLAN L</b>	50 mm
Transverse overlaps	50 mm
Gap between 2 metal sheet strips	4 mm

### **RENOLIT ALKORPLUS<sub>81040</sub>** contact adhesive (details)

Bonding **RENOLIT ALKORPLAN D**,  
**RENOLIT ALKORPLAN F** and **RENOLIT ALKORPLAN L**

Min. consumption 2 x 150 g/m<sup>2</sup>

### **RENOLIT ALKORPLUS<sub>81068</sub>** PUR adhesive

For bonding **RENOLIT ALKORPLAN A**

Consumption 350 g/m<sup>2</sup>

### **RENOLIT ALKORPLUS<sub>81064</sub>** SBR adhesive

For bonding **RENOLIT ALKORPLAN A**

Min. consumption 2 x 150 g/m<sup>2</sup>

Temperature for bonding  
≥ 5°C (PUR) - ≥ 10°C (SBR)

Temperature for hot-air welding	≥ 0°C
Temperature for solvent welding	5°C-20°C

### Detailing membrane

**RENOLIT ALKORPLAN D**

LDPE vapour barrier 0.25 mm

Self-adhesive vapour barrier

Up to interior climate class IV





Rely on it.

## Wish to be a future flat roof specialist?

### Training in: PVC – EVA –TPO

As manufacturers of PVC, TPO and EVA roofing membranes for many years we have been one of the leaders in the European market for synthetic roof coverings.

**RENOLIT** has a very comprehensive range of synthetic roof membranes and have over 45 years of experience which we would like to share with you.

## Complete and send this form for SYNTHETIC ROOF TRAINING

Company: .....

Surname: ..... First name: .....

Street: ..... Number: .....

Postcode: ..... Locality: .....

Phone number: ..... Fax : .....

Mobile: ..... E-mail: .....

Please send this form by e-mail to  
[matthew.adamson@renolit.com](mailto:matthew.adamson@renolit.com)  
or by fax to +44 1670 590096

Or contact our Technical Manager directly:  
**Tony Brown** Mob: 07944 778241





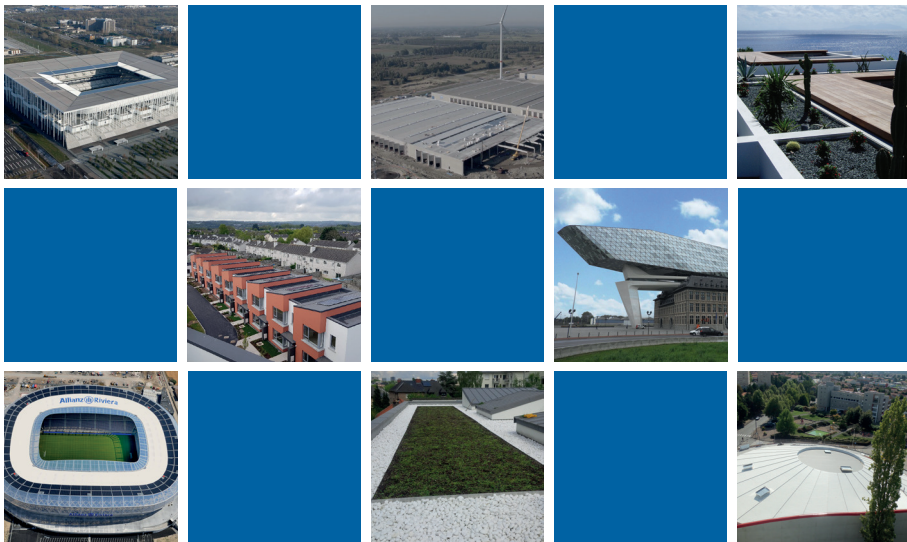

The British Board of Agrément have assessed the life expectancy of RENOLIT ALKORPLAN F used in the United Kingdom to be in excess of 40 years with extended maintenance.

RENOLIT ALKORPLAN roofing products and system have a standard warranty of 10 years, and are installed by approved contractors and installers who are trained and assessed by RENOLIT.

All RENOLIT waterproofing membranes for roofing are part of the ROOFCOLLECT® collection and recycling programme.

The RENOLIT Iberica S.A. factory in Barcelona is approved to ISO 9001/14001.

## [www.renolit.com/roofing](http://www.renolit.com/roofing)

**RENOLIT UK** Station Road - Cramlington, Northumberland NE23 8AQ - United Kingdom  
T +44 1670 718283 - F +44 1670 590096 - [matthew.adamson@renolit.com](mailto:matthew.adamson@renolit.com)

LAYDEX Ltd. - Unit 3 - Allied Industrial Estate - Kylemore Road - Dublin 10  
T +353(0) 1 642 6600 - F +353 (0) 1 642 6601 - [sales@laydex.ie](mailto:sales@laydex.ie)

LAYDEX (NI) Ltd. - Units 4 & 5 Falcon Way - Belfast BT 12 6 SQT + 44 (0) 2890 382 223 - F + 44 (0) 2890 382 230

**RENOLIT Belgium N.V.** - Export Dpt. - Industriepark De Bruwaan 43 - 9700 Oudenaarde - Belgium  
T +32 (0)55 33 98 51 - F +32 (0)55 31 86 58 - [renolit.belgium@renolit.com](mailto:renolit.belgium@renolit.com)

The information contained in the present commercial literature has been given in good faith and with the intention of providing information. It is based on current knowledge at the time of issue, and may be subject to change without notice. Nothing contained herein may induce the application of our products without observing existing patents, certificates, legal regulations, national or local rules, technical approvals or technical specifications or the rules and practices of good workmanship for this profession. The purchaser should verify whether import, advertising, packaging, labelling, composition, possession, ownership and the use of our products or the commercialisation of them are subject to specific territorial rules. He is also the sole person responsible for informing and advising the final end user. When faced with specific cases or application details not dealt with in the present guidelines, it is important to contact our technical services, who will give advice, based on the information at hand and within the limitations of their field of expertise. Our technical services cannot be held responsible for the conception of, nor the execution of the works. In the case of negligence of rules, regulations and duties on the part of the purchaser we will disclaim all responsibility. The colours respect the UV resistance required by EOTA, but are still subject to the natural change over time. Excluded from the warranty: aesthetic considerations in case of partial repair of deficient membrane covered by the warranty.



Rely on it.